

A	chair legs	1
B	ottoman legs	1
C	ottoman link tube	1
D	ottoman cushion	1
E	Ottoman base	1
F	chair base	1
G	dust guard	1
H	chair rubber pad	1
I	chair fixed ring	1

J	fix screw	9
K	chair seat	1
L	chair back rest	1
M	arm rest	2
N	steel bracket	2
O	Screw#15	8
P	Screw#20	8
Q	Screw#20	4
R	Aluminum pile	1

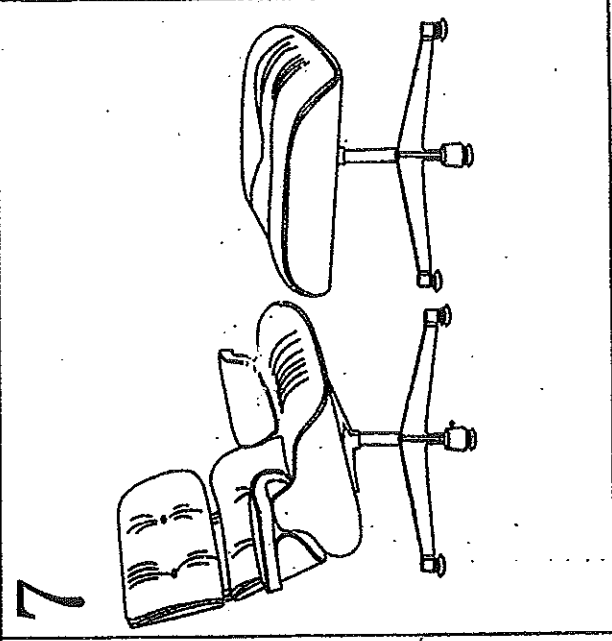
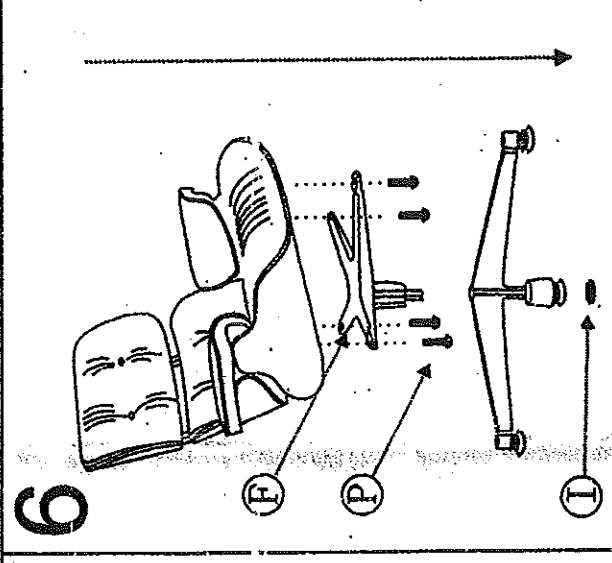
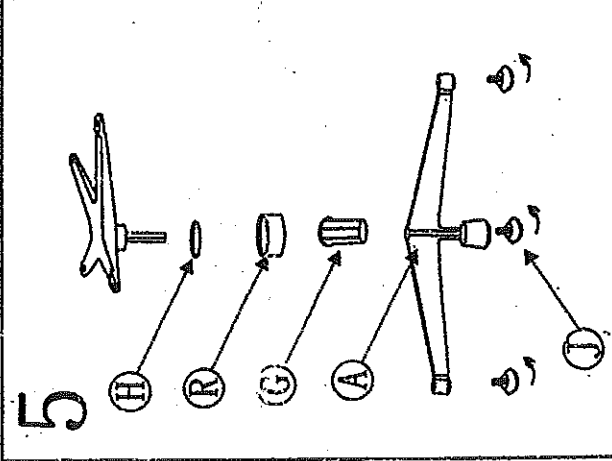
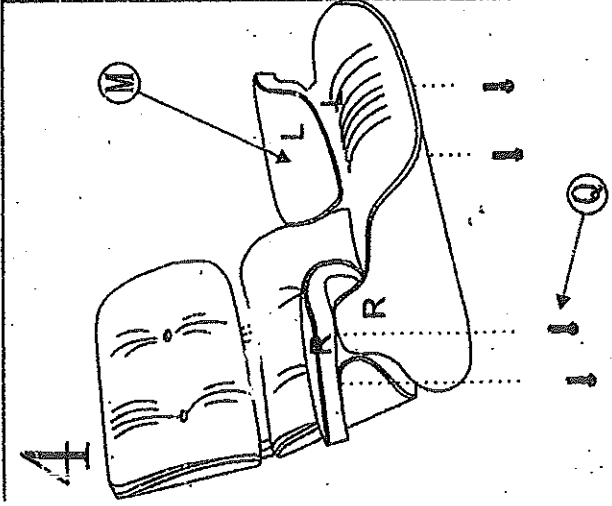
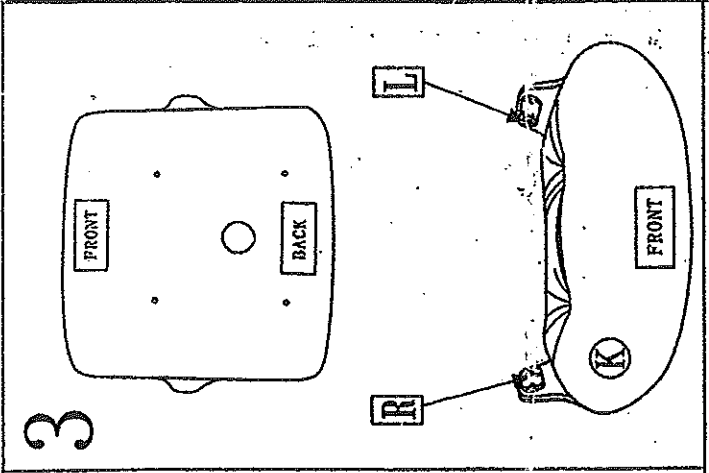
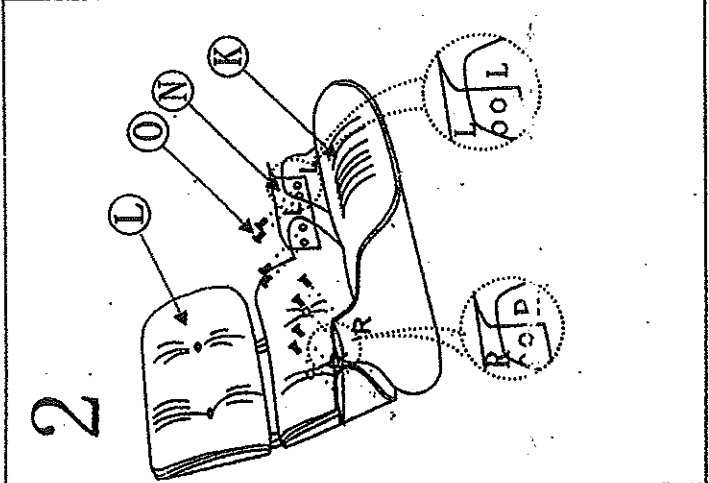
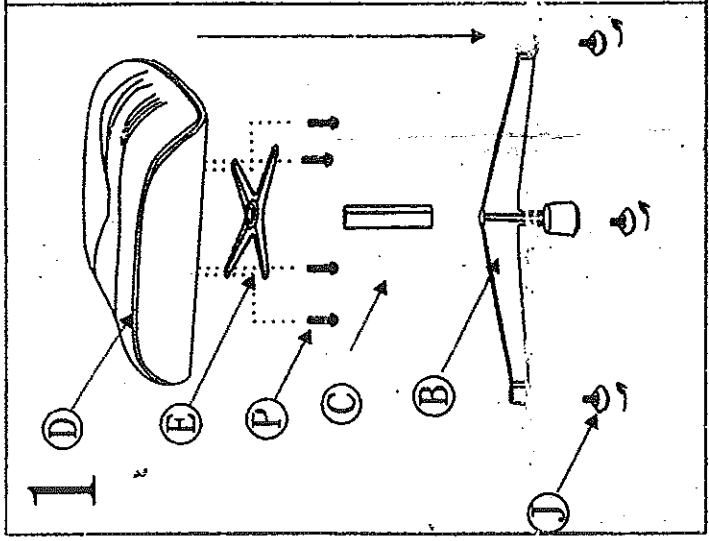

PS: 1. when assembling, please do use the packing material or protective film on bottom to avoid products being destroyed by touching floor directing.  
 2. When installing the base, insert all four screws and turn by hand only. After all four screws are tightened snugly by hand, use the hex tool included to tighten. DO not force screws with a wrench.